



biocoreTM pro

— patient supplement manual —

patents pending

If you have any questions or concerns about Biocore Pro, please contact customer service at

1.800.590.4155

Go to biocore.biotricity.com
to view the how-to videos



Dear Patient,

Your physician has prescribed the Biocore Pro system to record the electrical activity in your heart. The Biocore Pro will continuously record your entire ECG (electrical activity of your heart) rhythm while you are wearing it for later analysis and interpretation.

If you feel symptoms such as chest pain, palpitations, shortness of breath, or dizziness, at any time, you can press the MARKING button on the Biocore Pro – this will automatically mark your ECG recording, highlighting valuable data for your healthcare provider.



Chapter	Page
1. Information	6
2. Indications for Use	8
3. Biocore Pro Kit Contents	9
4. The Biocore Pro	10
5. Biocore Pro Component Description	11
6. Status Light Indicator Descriptions	12
7. Charging	14
8. Powering ON the Biocore Pro	15
9. App Features	16

Chapter	Page
10. Connecting the Electrodes	18
11. Electrode Placement	20
12. Alternative Electrode Placement	21
13. Marking an Event	22
14. Selecting a Symptom(s)	23
15. Removing Biocore Pro	24
16. Medical Device and Symbols	26
17. Troubleshooting	27
18. Warnings and Cautions	28

The Biocore Pro is a small, lightweight, ambulatory ECG device for the continuous recording of 3-channels of ECG signals for up to 30 consecutive days. Patient-activated manual cardiac events are captured and transferred to the server through a software application installed on your Bluetooth wireless-enabled mobile device, or via the built-in cellular back-up connection within the Biocore Pro.

The Biocore Pro attaches to the patient's body through three standard ECG electrodes supplied by a clinic or a monitoring center. High quality FDA-approved lead electrodes should be used.

The ECG recording is automatically transferred via the Biocare Health App (downloaded from the App Store or Google Play), or via built-in cellular back-up, and subsequently to the secure server. The ECG recording can be transferred and analyzed by qualified healthcare providers.

Biocore Pro does not provide the patient with diagnostic or interpretive statements based on the ECG data. Diagnosis and interpretation of ECG data is dependent upon the medical advice and guidance provided by a physician or trained healthcare professional.

**THE BIOCARE HEALTH
APP IS AVAILABLE ON**



INDICATIONS FOR USE

The Biocore Pro Monitor is indicated for use on adult patients 18 years or older who may be asymptomatic or who suffer from transient symptoms such as palpitations, shortness of breath, dizziness, light-headedness, pre-syncope, syncope, fatigue, chest pain and/or anxiety and may require cardiac recording on a continuous basis for up to 30 days. The Biocore Pro continuously records ECG data and upon detection by an ECG analysis algorithm or if manually initiated by the patient, the device automatically delivers the ECG record where it is presented and can be reviewed by a medical professional. The Biocore Pro is not intended to sound any alarms. The device does not deliver any therapy, administer any drugs, provide interpretive or diagnostic statements or provide for any life support. The Biocore Pro is not intended for use under the following conditions:

- Patients with potentially life-threatening arrhythmias who require inpatient monitoring
- Patients who the attending physician thinks should be hospitalized
- Infants weighing less than 10kg/22lbs
- Patients with implanted pacemakers
- Defibrillator use

BIOCORE PRO KIT CONTENTS

1. **BIOCORE PRO CASE**
2. **BIOCORE PRO**
3. **CHARGING CABLE**
4. **BIOCORE PRO QUICK GUIDE***
5. **BIOCORE PRO PATIENT SUPPLEMENT USER MANUAL***

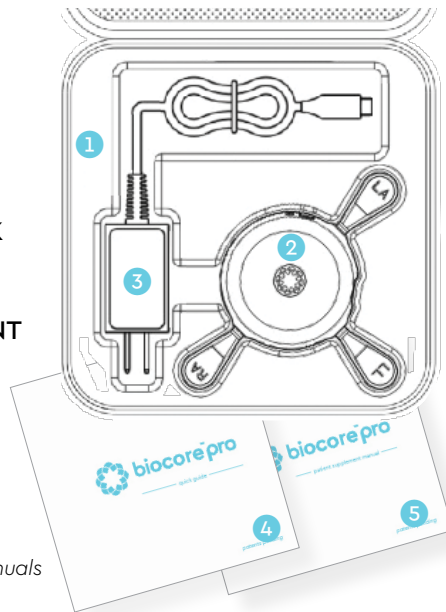

**Consult the app for the latest Biocore Pro user guides and manuals*

**THE BIOCARE HEALTH APP IS AVAILABLE
FOR ANDROID OR iOS, GET IT FROM:**



1. STATUS INDICATOR LIGHT

**The light will turn off when in power-save mode. Press POWER or MARKING button to light up the device.*

2. MARKING BUTTON

3. POWER BUTTON

4. CHARGING PORT







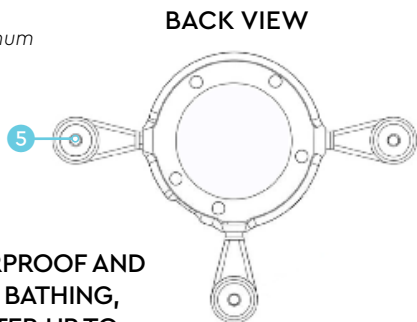
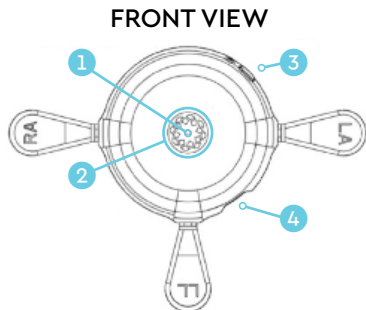





**Biocore Pro requires a minimum charge time of 1 hour.*

5. SNAPS FOR ECG ELECTRODES

BIOCORE PRO IS WATERPROOF AND SAFE FOR SHOWERING, BATHING, OR SUBMERSION IN WATER UP TO A DEPTH OF 3 FEET



COMPONENT	DESCRIPTION
Status Indicator Light	See pages 12-13 for Status Indicator Light descriptions.
Marking Button	The button used to mark user-initiated events. Button houses the Status Indicator Light.
Power Button	The button to power ON/OFF the Biocore Pro.
Charging Port	The connector into which the supplied charging cable is plugged when charging Biocore Pro.
Snaps for ECG electrodes	The components which connect to ECG electrodes.

STATUS LIGHT	INDICATOR	DESCRIPTIONS
No Light		Biocore Pro is in power-save mode – it is recording and monitoring normally. Press POWER or MARKING button to light up the device.
Solid Green		Biocore Pro is powered ON and not engaged in a study.
Solid White		Biocore Pro has received the START STUDY command – user acknowledges by holding MARKING button for 5 secs.
Slow Blinking Green		Biocore Pro is engaged in a study.
Blinking Blue		Biocore Pro battery is low.
Slow Blinking Blue		Biocore Pro is charging.
Blinking Yellow		Biocore Pro has encountered internal error(s).
Solid Blue		Biocore Pro is fully charged.
Blinking White		Electrodes disconnected or study is paused.
Blinking Green		Study is completed and being uploaded.
Fast Blinking Blue for 2 sec.		Biocore Pro is powering ON .
Slow Blinking White		User marked manual Event is accepted and processed.

CHARGING

CAUTION: Do not charge the Biocore Pro while connected to the patient's body with electrodes.

Ensure the Biocore Pro battery is fully charged before use.

- **CONNECT** the supplied charging cable to the Biocore Pro and **PLUG** the AC into the wall outlet.

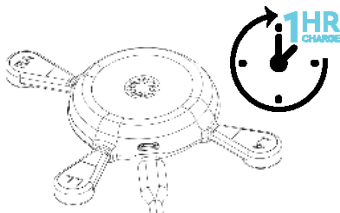

The user can also monitor the battery charging progress in the mobile app when available (see **APP FEATURES**).

STATUS LIGHT	INDICATOR	DESCRIPTION
Solid Green		Biocore Pro is powered ON and not engaged in a study.
Slow Blinking Blue to Solid Blue		Biocore Pro is charging. When light stops blinking, battery is fully charged.

POWERING ON THE BIOCORE PRO

Turn on the Biocore Pro by pressing the **POWER** button on the device.

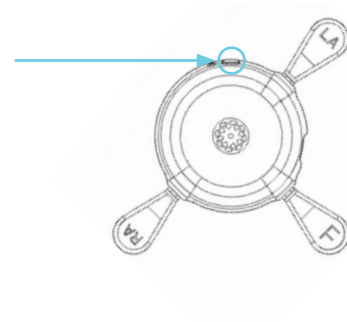

STATUS LIGHT	INDICATOR	DESCRIPTION
Fast Blinking Blue to Solid Green		The Status Light, inside the round Marking Button, will blink Blue for 2 sec and then remain lit in Green.
Slow Blinking Green		Biocore Pro is engaged in a study.

THE BIOCARE HEALTH APP IS AVAILABLE ON



The Biocare Health App can be installed on any mobile device with the latest Android or iOS operating system. When connected, it provides a secure communication bridge between the Biocore Pro, Bluetooth wireless connection, and the data server.

To use the App simply:

1. Download the app
2. Sign up to create your profile
3. Verify your email address
4. Sign in
5. Enter the reference code received through email/SMS to track the status of Biocore Pro during your heart study

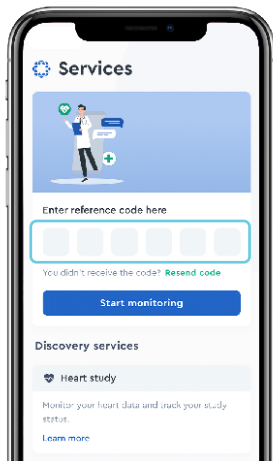

16

OTHER APP FEATURES INCLUDE:

- Use the **MARKING** button to track symptoms
- Check device status
- Check electrode connection status
- Check study status
- Check battery status

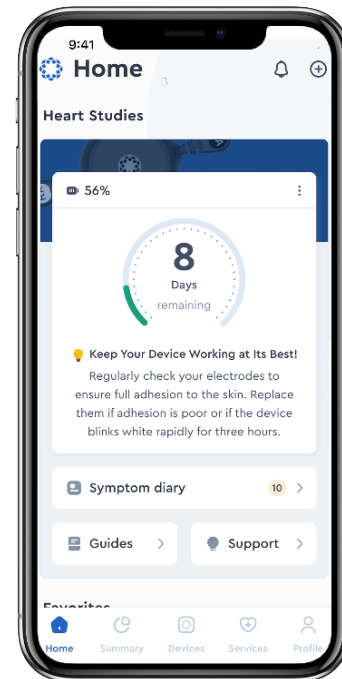

Newer versions of the app may appear differently than shown.

17

The quality of the ECG signal greatly depends on the contact between the electrode and the patient's skin. Proper preparation of the patient's skin is required for obtaining a quality ECG recording. It is best to refer to your electrode manufacturer for instructions on proper skin preparation techniques. However, the following points can assist in obtaining quality ECG recordings:

- Sit on a chair for skin prep and electrode placement.
- **'SNAP'** ECG leads to NEW electrodes against a hard surface. Listen for the **'SNAP'** to ensure lock. Apply the electrodes to each of the three snaps of Biocore Pro.
- **SHAVE** any hair necessary from the areas where the electrodes are to be placed.

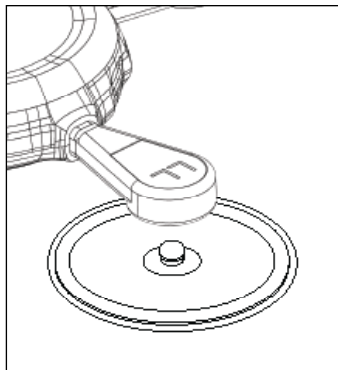

- **CLEAN** skin with water or rubbing alcohol and let skin dry thoroughly.
- **REMOVE** the protective tape from the electrodes.

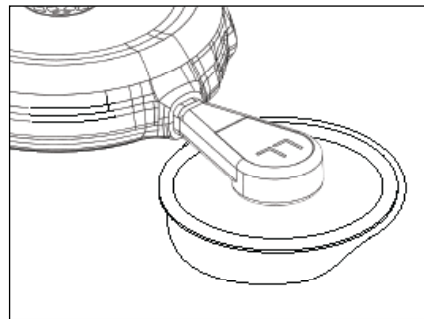

- **PLACE** the Biocore Pro with electrodes attached on the patient's skin surface as illustrated (see **ELECTRODE PLACEMENT** and **ALTERNATIVE ELECTRODE PLACEMENT**).



Generally, electrodes should be placed over bone structures. Artifact and noise may result from placement of electrodes over large muscles or fatty tissue.

ELECTRODE PLACEMENT

Place the Biocore Pro connected to the electrodes on your skin.

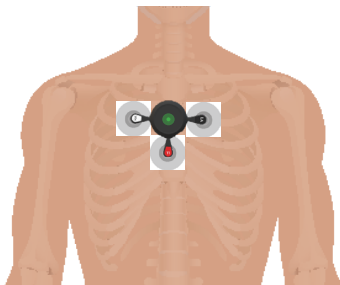
CENTER POSITION







LEAD	COLOR	LOCATION
	WHITE	Upper right portion of the chest, 2" - 3" below collarbone.
	BLACK	Upper left portion of the chest, 2" - 3" below collarbone.
	RED	Center of the chest.

ALTERNATIVE ELECTRODE PLACEMENT

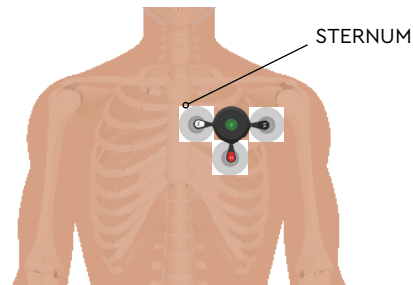
Place the Biocore Pro connected to the electrodes on your skin.

LEFT POSITION



LEAD	COLOR	LOCATION
	WHITE	Align RA electrode 2" - 3" below the left sternum and collarbone junction.
	BLACK	Align LA electrode 2" - 3" below left collarbone.
	RED	LL electrode.

MARKING AN EVENT

During a study in progress, the **MARKING** button may be pressed for **5 sec** to manually record symptoms being experienced as they occur. The Biocore Pro status light will slowly blink white indicating the user event has been recorded.

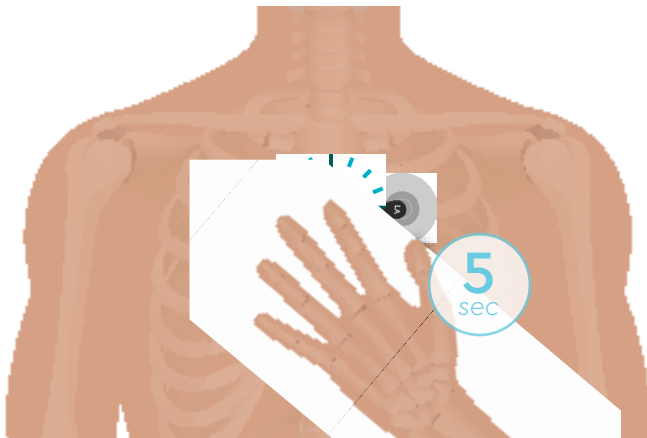

PLEASE NOTE: The Biocore Pro will retain data if not connected to the mobile app. If the Biocare Health app is not used, events will still be marked, but symptom(s) will not be recorded.

SELECTING A SYMPTOM(S)

When connected to the mobile app, the app will display a menu allowing the patient to select symptom(s) based on what they've experienced. After selecting symptom(s), the patient must press **SUBMIT** to record the symptoms.

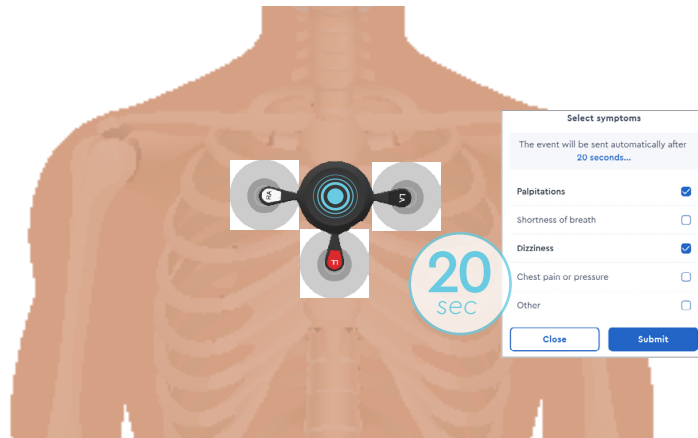

Follow these instructions:

! Failure to follow these instructions may lead to patient discomfort and/or damage to the Biocore Pro.

Detach snaps from electrodes **WHILE WEARING** Biocore Pro. Detach each snap from electrodes **ONE AT A TIME**.

STEP 1:

While still attached to patient, hold electrode firmly in place with finger(s).

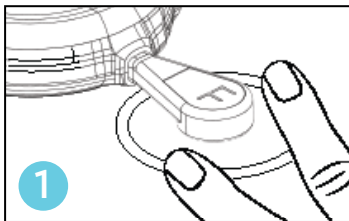
**STEP 2:**

Grip the snap and gently pull upward until it unsnaps and detaches from the Biocore Pro.

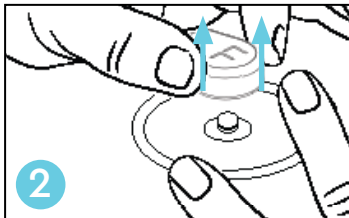





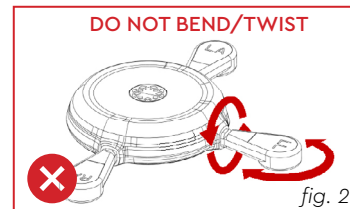
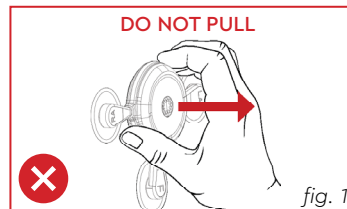

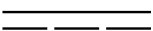

To avoid damaging the Biocore Pro:

- ✗** **DO NOT** remove by **PULLING** the Biocore Pro off of chest *before detaching from electrodes (see fig. 1)
- ✓** **DO** unsnap the Biocore Pro from the electrodes **ONE AT A TIME**
- ✗** **DO NOT TWIST** or **BEND** Biocore Pro snaps (see fig. 2)
- ✓** **DO** grasp each snap and gently pull upwards until it is detached from the electrode
- ✓** **DO** follow electrode manufacturer's instructions for proper removal of electrodes



*If Biocore Pro has been removed from patient with electrodes still attached, separate by gently lifting the snap **STRAIGHT UP** from the electrode, without bending or twisting the snap.

MEDICAL DEVICE AND SYMBOLS

SYMBOL	DEFINITION
	Direct current 5V dc 1 Amp. IEC 60601-1:2012 D.1 4
	Type BF electrical isolation, Biocore Pro is not defibrillator proof. IEC 60601-1:2012 D.1 20
	Follow instructions for use! IEC 60601-1:2012 D.2 10
	MRI unsafe. https://www.fda.gov/media/74201/download VII. B.
	This is the FCC logo indicating compliance with the FCC rules for wireless devices. 784748 D01 General labeling and Notification v09r01, 2.5
	CAUTION: Federal law restricts the sale of this Biocore Pro by or on the order of a licensed physician. 21CFR 801.109
	Dust tight, no ingress of dust up to 8 hours. Protection against immersion in water up to 3 feet for up to 30 min. IEC 60601-1-11:2015 Table A.2
	Power Button, Resume from Standby mode. IEC 60601-1:2012 D.1 29

TROUBLESHOOTING

PROBLEM	SOLUTION
No Power	Check the battery power level and recharge the Biocore Pro.
Low Battery	Recharge the Biocore Pro.
Biocore Pro does not charge	Charge for at least 20 min before powering ON. If status light does not slowly blink blue to indicate charging, call Biotricity Customer Service.
Noise artifacts on the ECG signal	Ensure all electrodes are securely attached to the patient and the electrodes are of recommended quality. Ensure snaps for ECG electrodes are not broken.
Status Light does not slowly blink white when the Marking button is pressed for user-marked manual event	Contact Biotricity Customer Service.
Any other errors	Contact Biotricity Customer Service.



WARNINGS AND CAUTIONS

WARNING: Consult your health care professional with questions regarding the Biocore Pro System.

WARNING: If you are experiencing life threatening symptoms, call 911 or your physician to seek immediate medical attention.

WARNING: Not for use in Magnetic Resonance Imaging (MRI) environment. Biocore Pro is labelled as MRI unsafe.

WARNING: Use of accessories, transducers and cables other than those specified or provided by the manufacturer of this equipment could result in increased electromagnetic emissions or decreased electromagnetic immunity of this equipment and result in improper operation.

WARNING: Portable RF communications equipment should be used no closer than 37 cm (15 inches) to any part of the Biocore Pro, including ECG leads. Otherwise, performance degradation of this equipment could result.

WARNING: Pacemaker signals present when viewing the ECG data must be examined with caution, as it may not be a true representation of the actual pacemaker stimulus amplitude.

WARNING: Biocore Pro has not been evaluated for use with patients utilizing a pacemaker.

WARNING: Do not use a defibrillator on a patient wearing the Biocore Pro. The Biocore Pro is not protected against defibrillation shocks. Use of a defibrillator can lead to injuries or burns to the patient and malfunction of the Biocore Pro. Remove the Biocore Pro prior to defibrillation.

WARNINGS AND CAUTIONS (continued)

CAUTION: US Federal law restricts sale of this Biocore Pro by or on the order of a licensed physician.

CAUTION: Biocore Pro should only be used by trained personnel. All healthcare professionals are trained by Biotricity personnel on the proper operation of the Biocore Pro using the IFU. The healthcare professionals will train patient and caregiver using the IFU on how to charge the Biocore Pro, connect the device manually mark recording when feeling a symptom, and outline device warnings and precautions.

CAUTION: If the Biocore Pro is physically damaged, immediately discontinue use, remove the Biocore Pro, and contact Biotricity customer service.

CAUTION: Follow Biocore Pro cleaning instructions thoroughly between patients to avoid cross-contamination.

CAUTION: Disconnect the Biocore Pro from the patient electrodes before charging the device.

CAUTION: Disconnect the Biocore Pro from the patient electrodes before using a defibrillator.

CAUTION: If showing signs of skin sensitivity to the Biocore Pro or electrodes, discontinue use and contact your physician.

CAUTION: Biocore Pro is not to be in-contact with anything other than medical grade electrodes placed on the body surface.

CAUTION: Biocore Pro only works with the supplied AC charger cable. Do not attempt to connect any other cable to the as this could cause damage to the Biocore Pro or injury to the patient.

CAUTION: To ensure that the Biocore Pro has adequate battery power to continuously monitor, record and transmit patient ECG signals, the battery must be recharged on a routine basis based on the Biocore Pro instructions and settings.

CAUTION: Keep children from playing with AC charger cord as it can pose a risk of strangulation. To prevent damage to cables and the risk of electric shock, prevent pets, pests and children from chewing on cables.

CAUTION: To receive the best recording results, patients should stay away from heavy electrical equipment or other sources of electromagnetic interference. Equipment such as electric blankets and heating pads are included in this group.

CAUTION: Data received from the Biocore Pro should be reviewed by qualified medical professional prior to any action being taken.

CAUTION: Bright light may make Biocore Pro light difficult to see; shield from direct light.

CAUTION: Biocore Pro must not be exposed to extreme temperatures (apart from the environmental specifications indicated).



Biotricity Inc.
203 Redwood Shores Pkwy,
Suite 600
Redwood City, CA 94065
1.800.590.4155

-  biotricity.com
-  cs@biotricity.com
-  [@biotricity_inc](https://twitter.com/biotricity_inc)
-  [biotricity inc](https://www.facebook.com/biotricityinc)
-  [biotricity inc](https://www.linkedin.com/company/biotricityinc)